

Project design and implementation of a laboratory for verification / calibration oceanographic equipment



Objetives

- Range work: 35°C to -2°C
- Bath Stability: 0.001°C
- Ability to Contribute heat: $0.1^{\circ}\text{C}/\text{min}$
- Resolution of the heat system: $0.1\text{m}^{\circ}\text{C}$ (in all range)
- Ability to Contribute cold: $0.25^{\circ}\text{C}/\text{min}$ (to 15°C)
- Resolution of the cold system: $0.05\text{m}^{\circ}\text{C}$ (to 15°C)

Calibration Bath Desing

- Volume: 300 liters
- Heater System:
 - One Resistor of 2000 watts
- Cooling System:
 - One coil of 20 turns 12x14 mm \emptyset polyamide (inside the Salt water bath)
 - Water Mixer (to homogenize the temperature)
 - Antifreeze Glycol (-35°C)
- Standard Sensors (Temp. and Cond.)
 - SBE 3plus and SBE 4 (CTD SBE 911plus sensors)

Ancillary equipment of the instalation

- Additional items to produce and store the cold (to cool and store the Antifreeze Glycol)
 - Antifreeze Glycol Tank (270 liters)
 - 2 Compressors of 1450 watts
 - 2 Pumps of 30 liters/min
 - 2 Electronic Proportional Valves
 - 2 Flowmeters (0.3 to 10 meters/seg)

Schematic of the installation

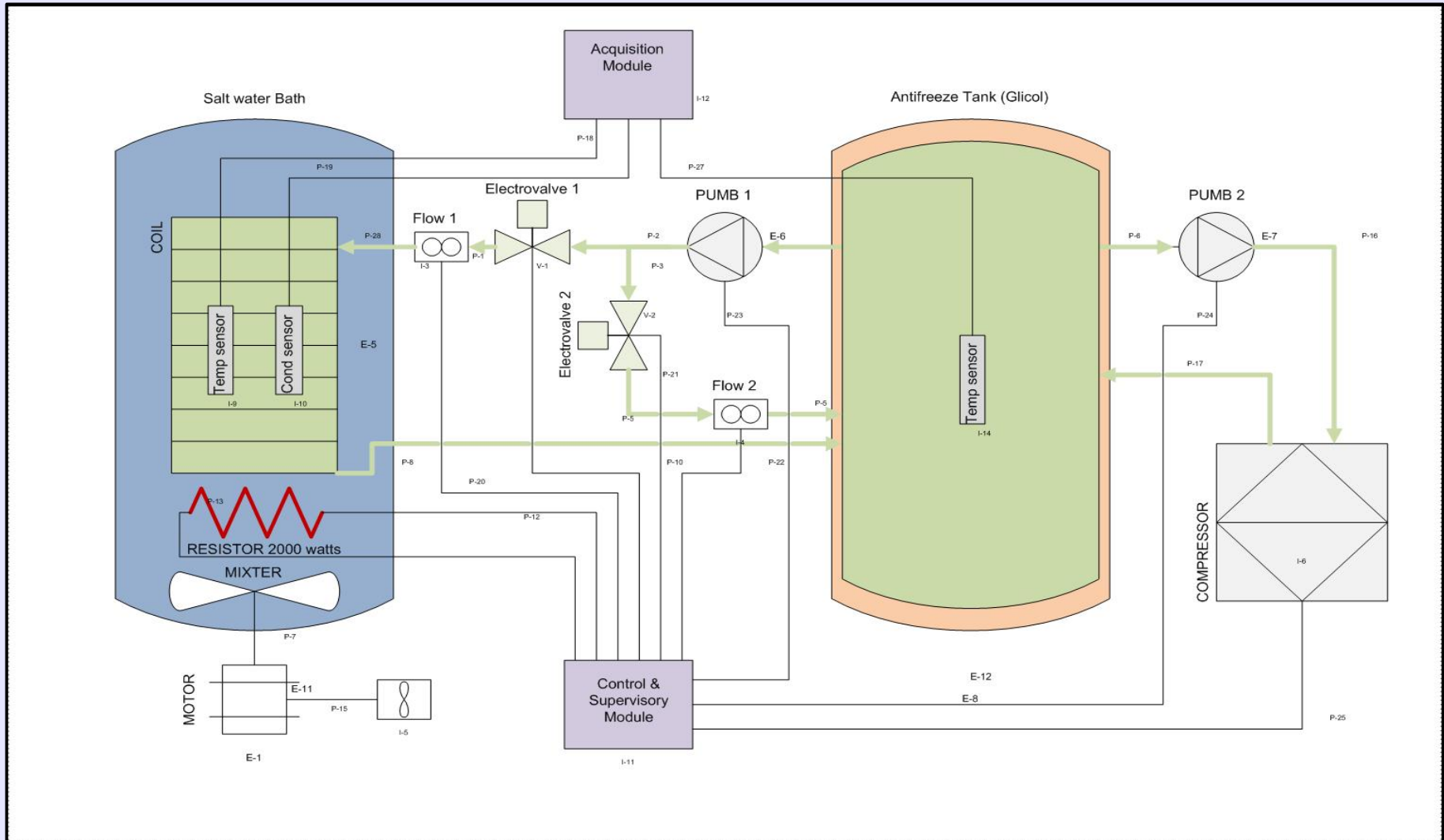

Verification/Calibration Lab.



Temperature Data

Extracting heat from the water bath

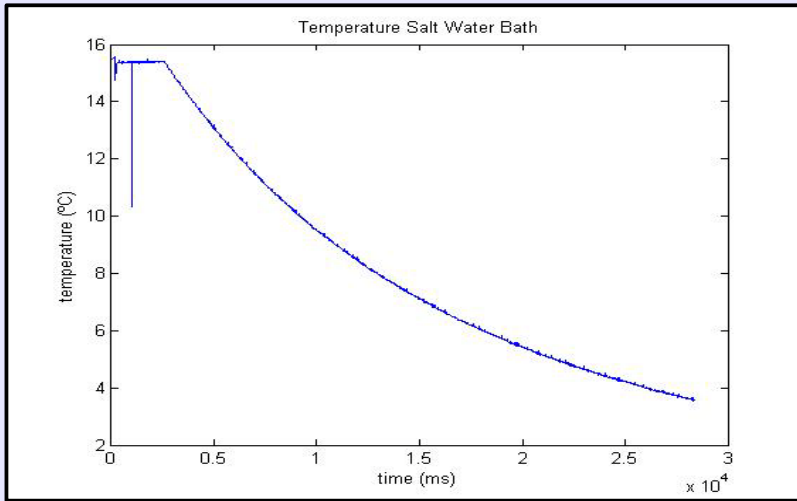

Providing heat to the water bath

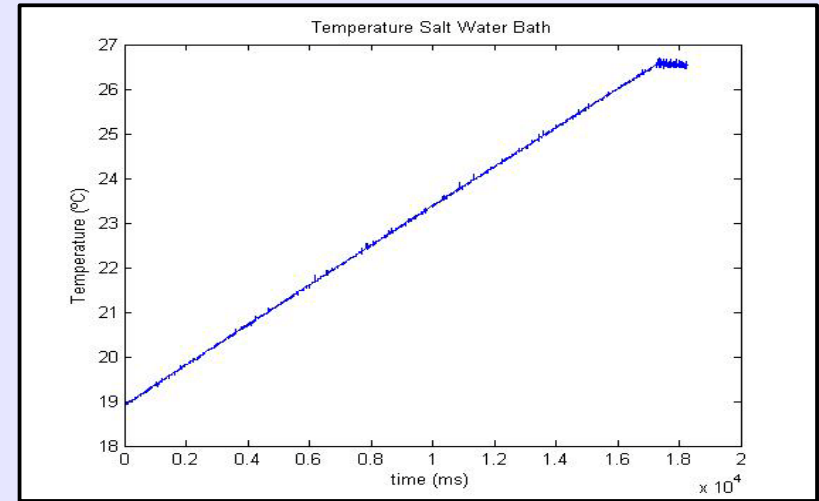

The heat extracted from the water bath is stored in the tank glycol

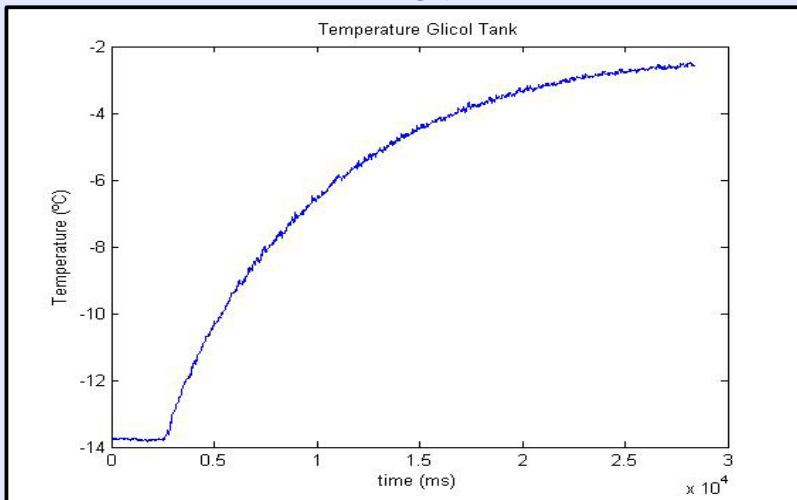

The glycol temperature is constant

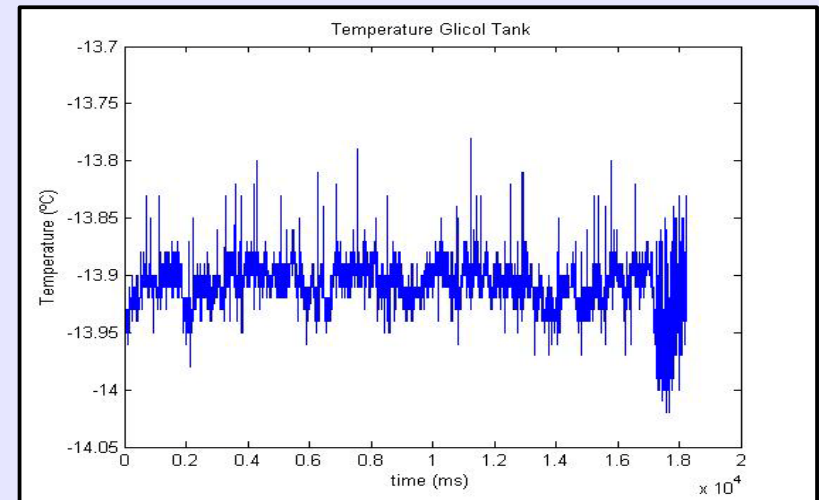

Temperature discretization. the exponential becomes lineal in a local analysis

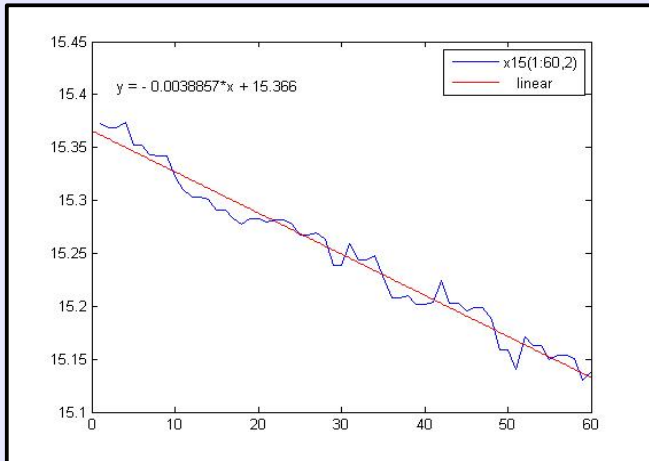

T=15,38 Slope=-0,23°C/min

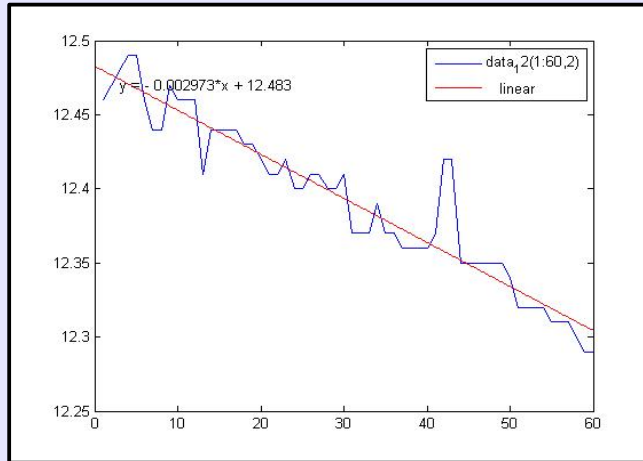

T=12,48 Slope=-0,18°C/min

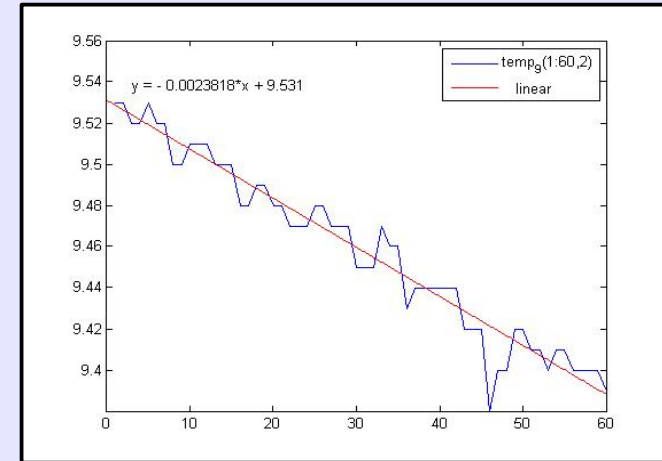

T=9,53 Slope=-0,14°C/min

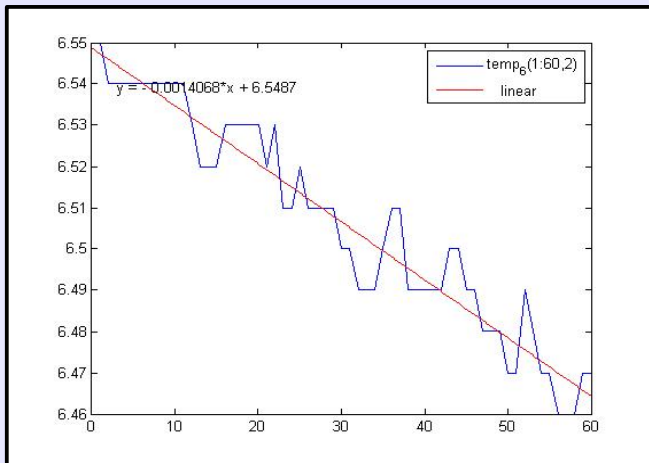

T=6,55 Slope=-0,085°C/min

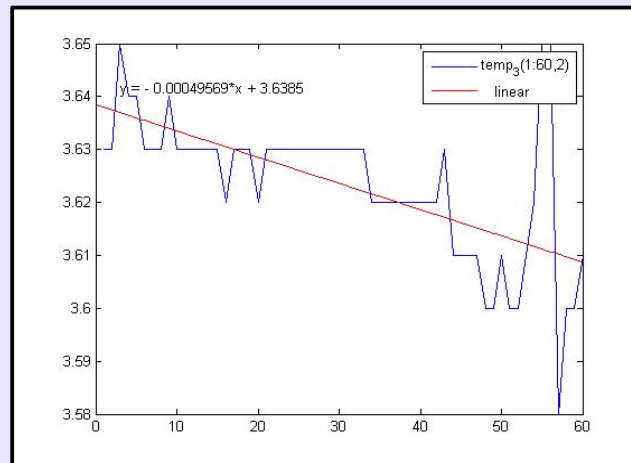

T=3,64 Slope=-0,03°C/min

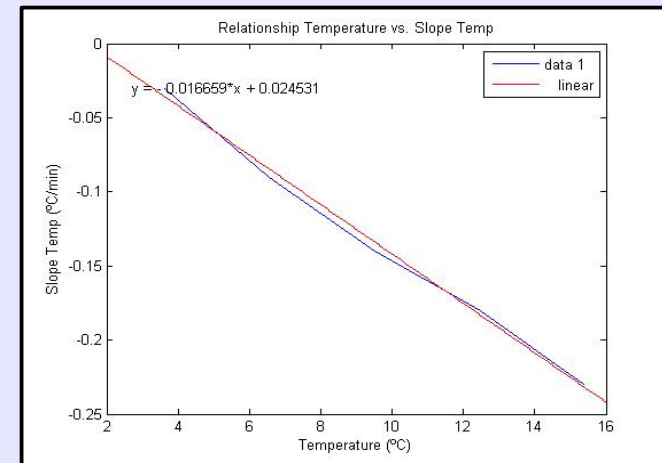

Relationship between Temp and slope

The next step: designing and implementing control temperature

- After the installation of the essential elements, such as tanks (water and glycol), pumps, compressors, proportional valves, flow meters, pipes, sensors, electric lines, electrical box of protection and control, etc., the next step is to design and implementation of **electronic acquisition** and **electronic control and supervision** of the installation.
- So, It will be designed two electronic applications in parallel based microController. One dedicated to the acquisition of the temperature and conductivity sensors and the other dedicated to the control strategy for the water bath and supervision of the installation.

How will the bath control system work?

- To reach a temperature control, if this is lower than the current, the control system open the proportional valve completely to arrive as soon as possible at that temperature.
- In this period of time, the control system evaluates which is the ability of glycol to extract heat from the water bath.
- Reached the temperature control, the control system determines the optimal opening value of the proportional valve (0-100%) in function to the capacity of extracting heat that has glycol at this time. The opening value of the proportional valve will be constant throughout the period of calibration point.
- Once the control system has determined the opening value of the proportional valve for calibration at that point, the control will be dedicated to manage the resistor. The resistor will try to correct that extraction of heat produced by the proportional valve and glycol.

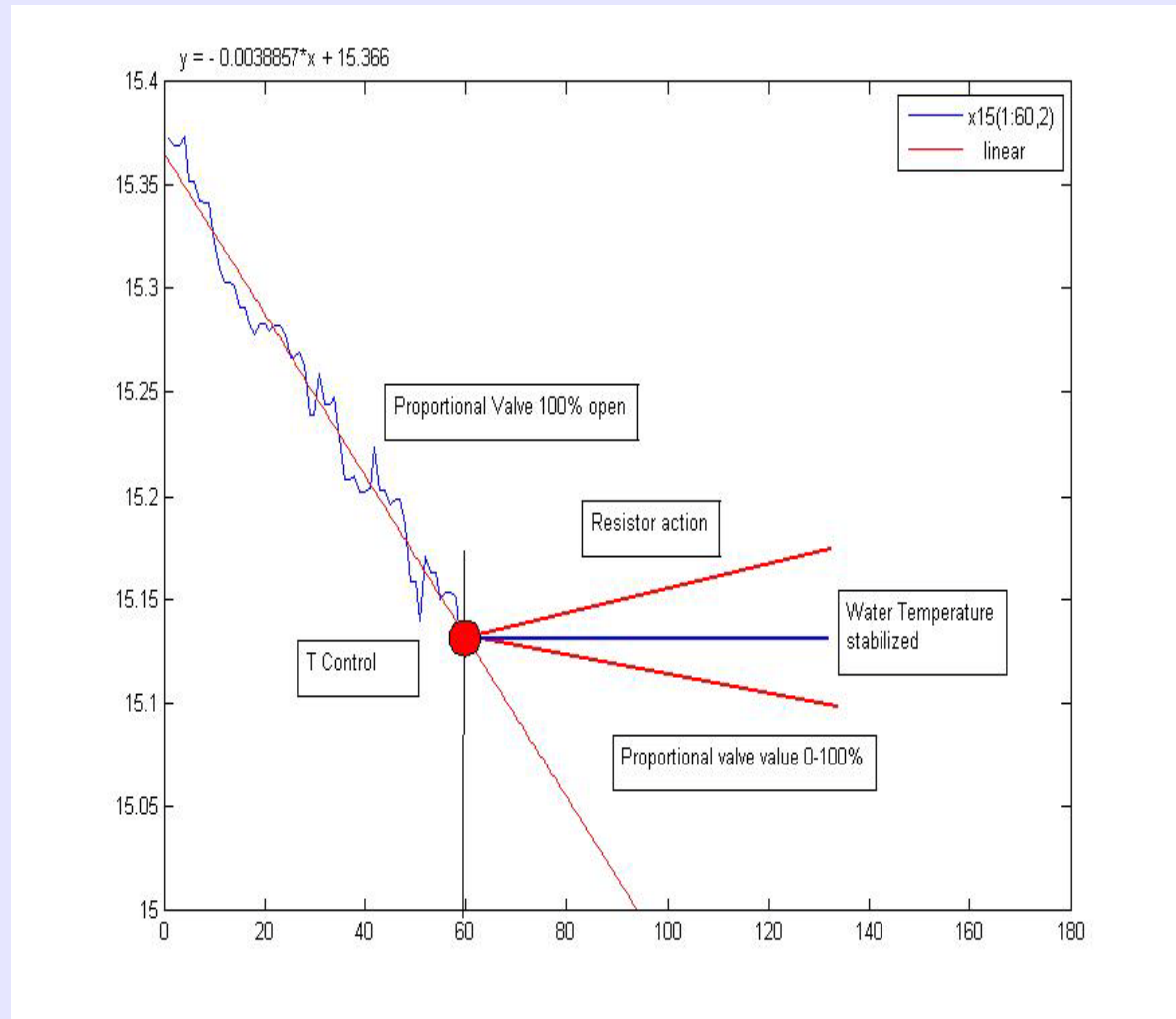

Control Strategy: Timing waveforms Acquisition Module

The **standard temperature sensor** is the same for the reference temperature control system. The sensor that will perform these functions will be an SBE 3plus (waiting to integrate in the system an Automatic Temperature Bridge type F18 (ASL)). The output of the SBE 3plus sensor is in frequency (+ /-0.5V square wave) of range: 2 – 6KHz.

To measure the Temperature and Conductivity data we use a DSPIC30F6014A (a 16-bits microController) running at 40MHz.

- 1. Beginning of the Temperature and Conductivity measurement.
- 2. Don't Matter.
- 1-3. Time period to measuring de Temperature and Conductivity (20ms).
- 3. Finish the Temperature and Conductivity measure. Send Temperature data to Control Module.
- 4. Don't Matter
- 3-1 Processing time. Conversion raw to ascii data to show to the display. Send Temperature and Conductivity data to PC

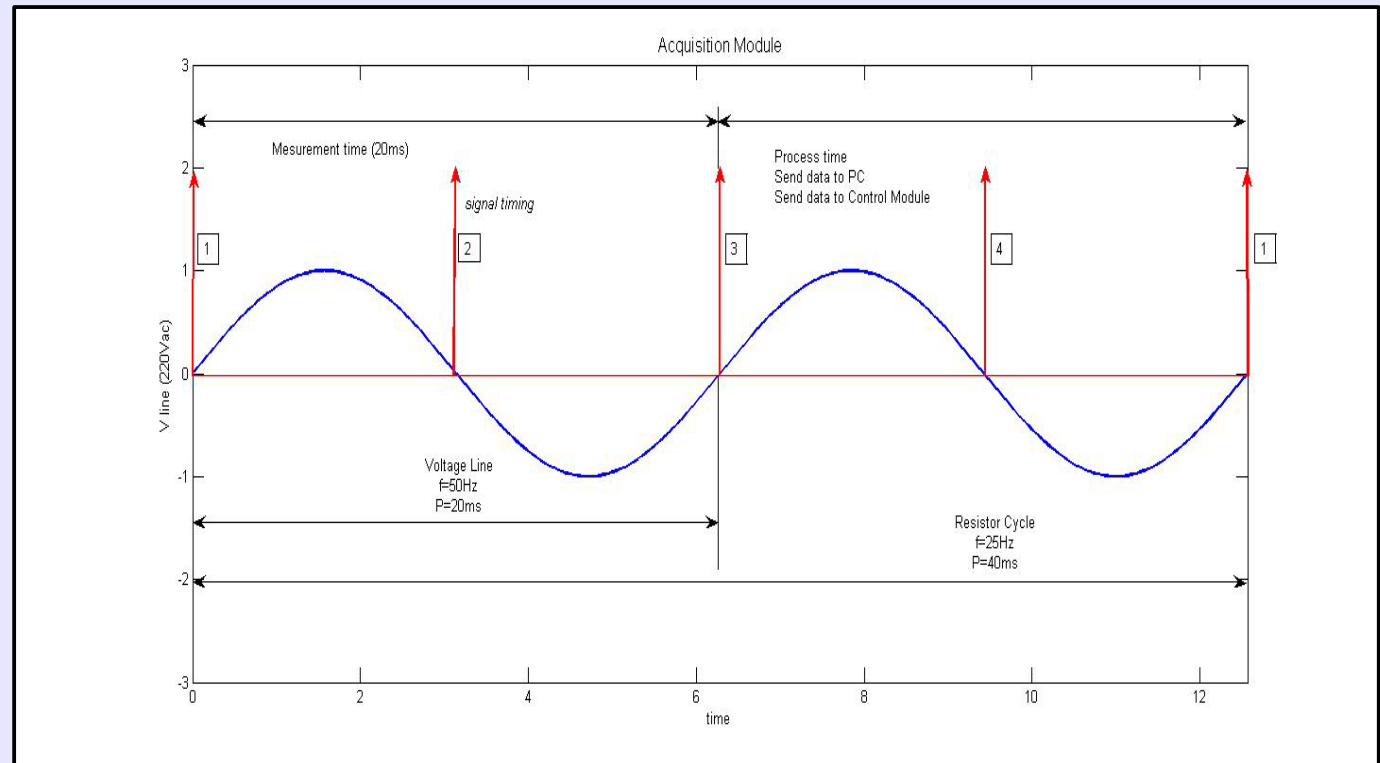

Control Strategy: Timing waveforms Control Module

The Control Module monitors the line voltage (220Vac/50Hz) and generates (through a circuit designed for this) the timing signal. This timing signal is shared by both circuits (the Acquisition and Control Module). This signal timing is a square waves of 5V at 100Hz (all zero crossing).

The Control Module uses a PIC18F8022 (8-bits microController) running at 40MHz.

- 1. The Control Module carries out the control acción over the resistance. Switch ON or Switch OFF.
- 2. Don't Matter.
- 1-3. Processing time (20ms). Conversion raw to ascii data to show to display. Send Data to PC (voltage, current, flows...).
- 3. Receive the Temperature data from Acquisition Module.
- 4. Don't Matter.
- 3-1. The Control Module determines whether the next Resistor Cycle is switched ON or OFF.

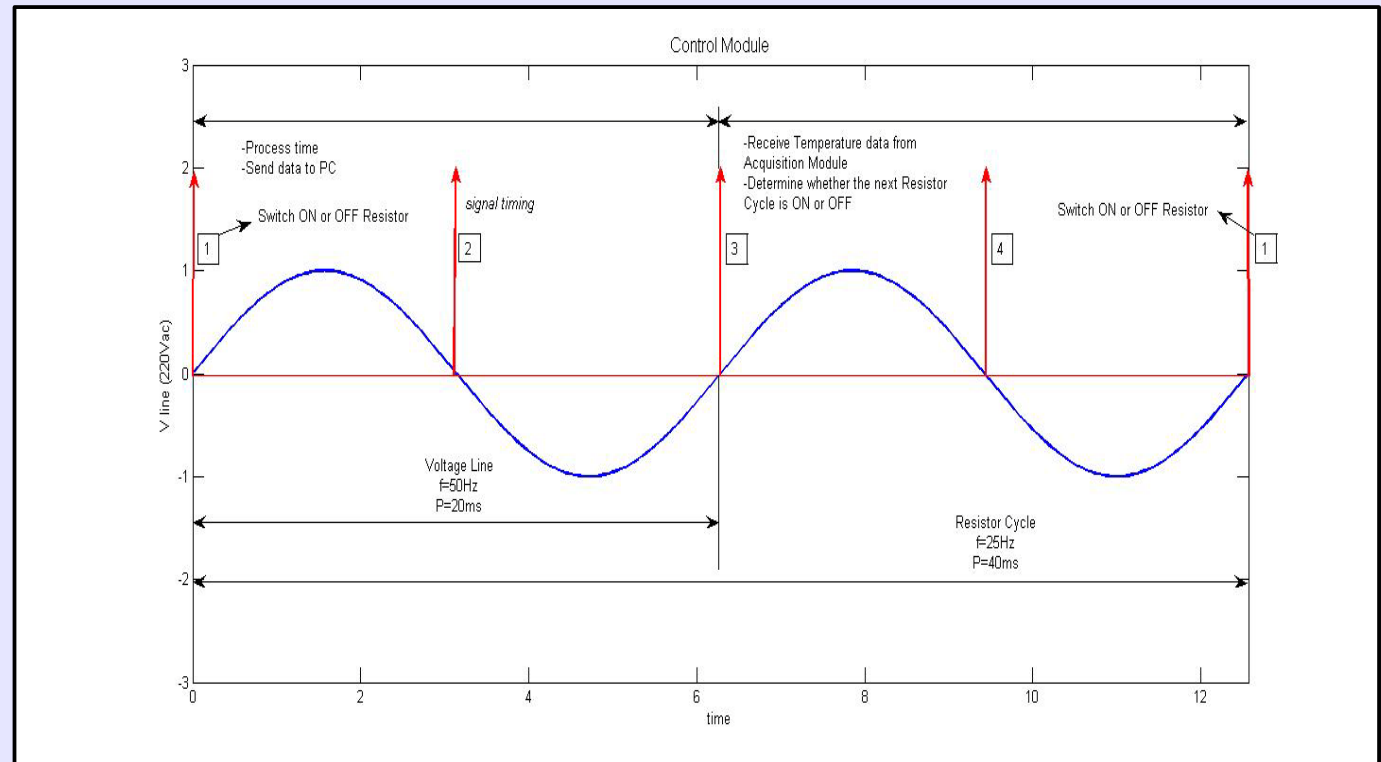

Block diagrams: Acquisition and Control Systems

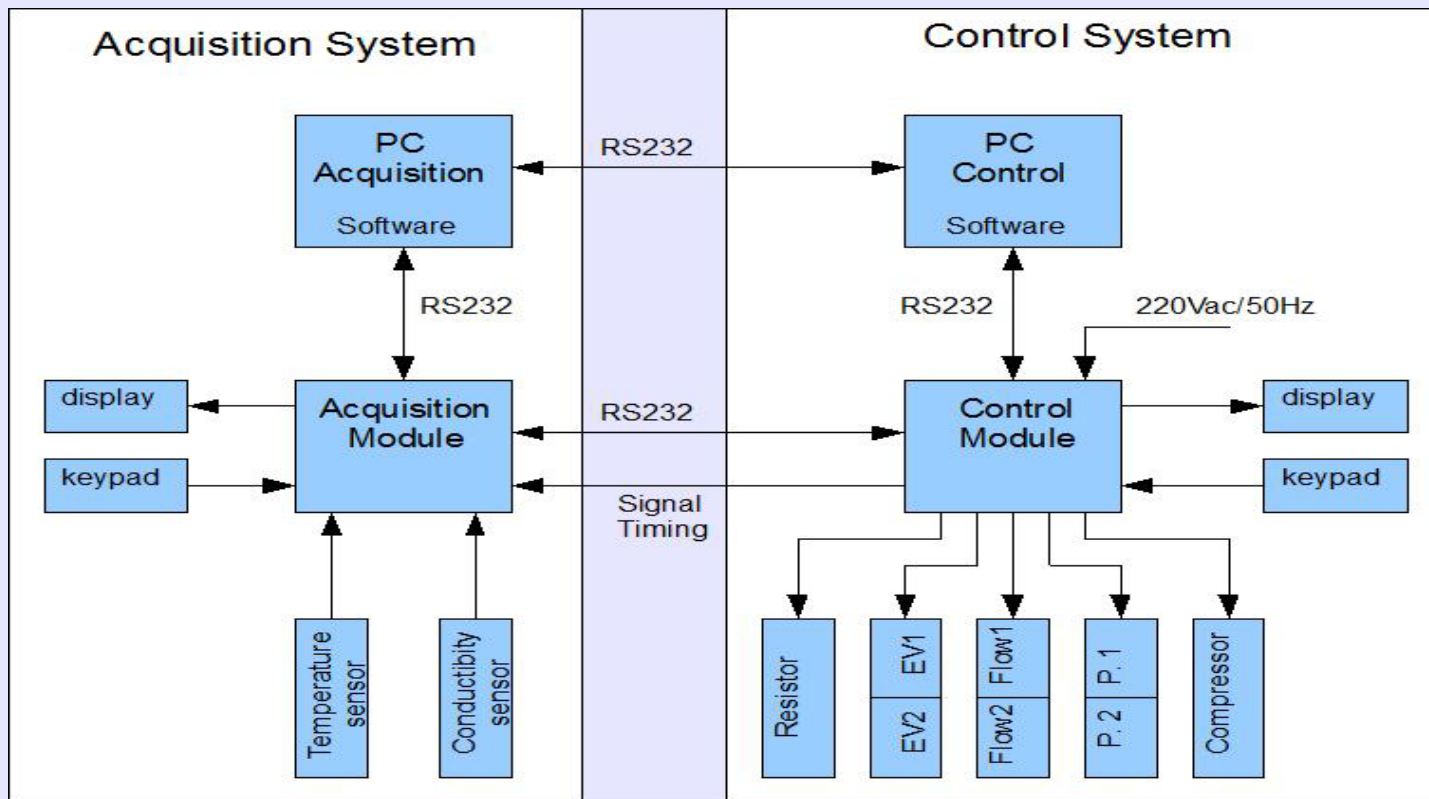

The **acquisition module** counts the pulses through an interrupt I/O pin (INT0) of the microcontroller and calculates the period of the Temperature and Conductivity sensors signal. To accomplish this, we have a 40MHz oscillator (800,000 clock cycles every 20ms).

Some Operational Amplifiers adapt the sensor signal to the microcontroller.

All this gives us an accurate chain measure of 1.25 mHz (at 1KHz) and 7.5 mHz (a 6KHz).

The Resistor is activated by a switch, a DIAC, whose GATE is connected to the microcontroller through a MOC ic. The proportional valves are connected to a DAC with a digital input of 8-bit parallel and an analog output of 0-10Vcc. The resolution of proportional valves are $10/256 = 0.04V$.

The compressor and pumps are activated by relays (to 12 Vcc).

The Flowmeters give a square signal of 0-24V whose frequency is proportional to the flow.

Acquisition and Control Cards

Displays and Keypads



Control 1

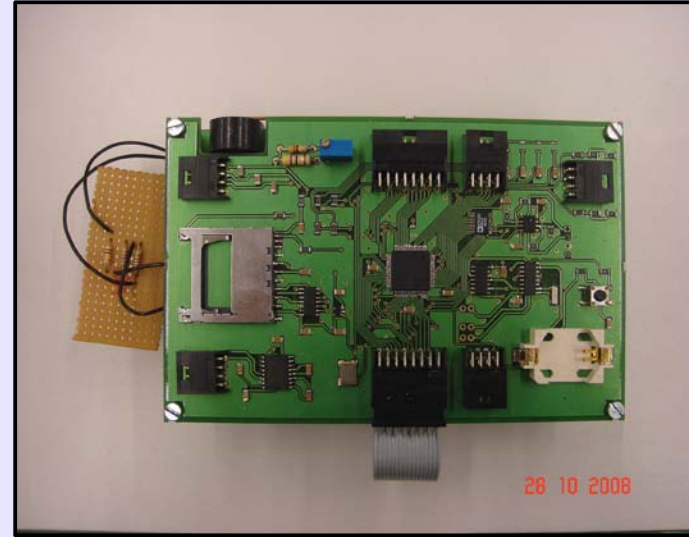

Acquisition

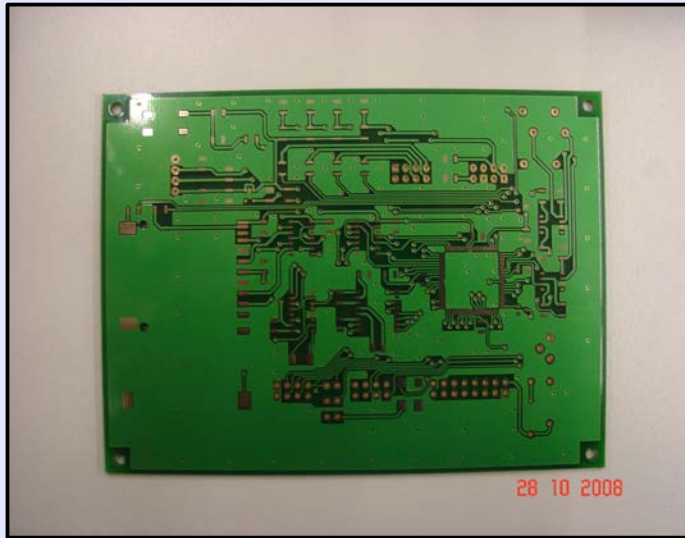

Control 2

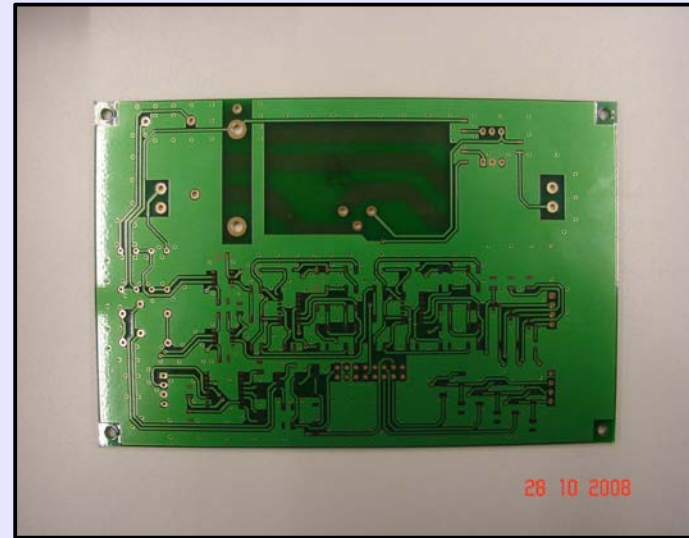

Assembly detail of Acquisition and control Modules



Farewell and close

.... And That's all

Thank you for your patience !!

Questions?